

Rare Animals of the World
4th Series

Vol.5

Juan Fernandez Fur Seal

Assembly Instructions



Thank you for downloading this paper craft model of the Juan Fernandez Fur Seal. By matching the names and numbered parts in the instructions, you and your family can complete a paper craft model of this rare and precious animal.

- Assembly instructions: Seven A4-sized sheets.
- Paper craft: Three A4-sized sheets with 13 parts in all

These instructions apply only to the "Juan Fernandez Fur Seal."
These Paper Craft parts are easier to work with when printed out on strong, thick paper (like postcard stock).

*In creating these Paper Craft models we use 110kg Kent paper stock

1

To begin

Tools and materials needed

-Ruler - scissors - blade cutter or "Exacto-knife" - awl or other pointed tool (for making a folding crease) - felt pen - pin set - glue - hand towel (for cleaning your fingers) - dictionary or other heavy book (to press the papers flat).

Items of Caution

*Take care when using sharp or pointed objects or when using bladed cutting tools. Place a heavy sheet of paper under the paper you want to cut.

*Use glue and other adhesives only in well-ventilated areas.

*When printing, use a slightly reduced font size. There may be differences in dimensions, depending on the type of printer used.

2

How to assemble

*Follow the working method and markings carefully.

*Cut carefully along the outer line with cutting blade, Exacto-knife or scissors.

One - point Advice

*Cut carefully with cutting blade, Exacto-knife or scissors.

*For folding parts, first use an awl or other pointed tool to make a light crease along the dotted or solid line. This will make the folds straight. Avoid making strong creases, as this will cause the paper to tear.

*As an adhesive, white wood glue is recommended. Avoid over application as this may cause the paper to wrinkle.

*Before beginning assembly, test adhesive amounts on extra paper.

*Occasionally, white spots will be apparent on folds and cuts. Use a marker or pencil to fill in these spots. It is recommended that this be done after each stage of assembly because coloring becomes more difficult once parts are assembled.

Basic working method and markings

Solid lines

Fold along these lines. The printed surface should be on the outside of the folded shape.

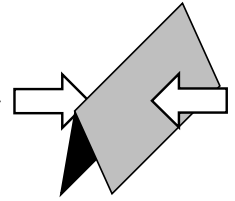

Broken lines

Fold along these lines. The printed surface should be on the inside of the folded shape.

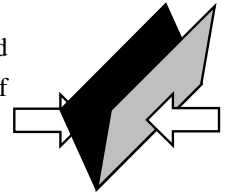

Dotted line

Cut along these lines.

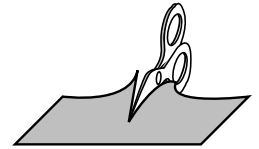

Do not fold or cut the parts marked X.

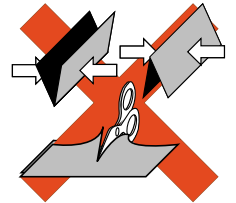

Cut out parts marked with an asterisk(*).

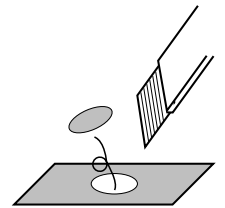

Red dots are the reference positions for gluing surfaces.

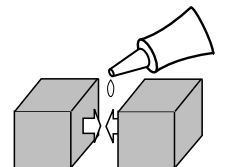

Please refer to the "Basic working method and markings" symbol chart on Page 2 to assemble each part.

Indication of Working Methods



Fold or Curve



Glue

Instructions for Juan Fernandez Fur Seal

1. Assembly of Mouth Fold each relevant part according to the assembly symbols.

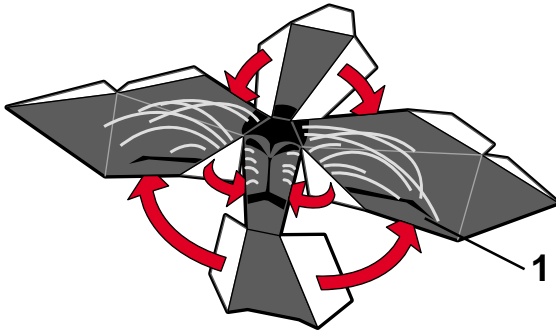

Reference photo

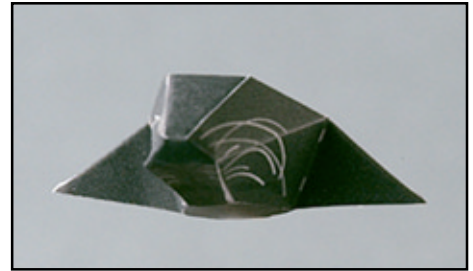

2. Assembly of Head

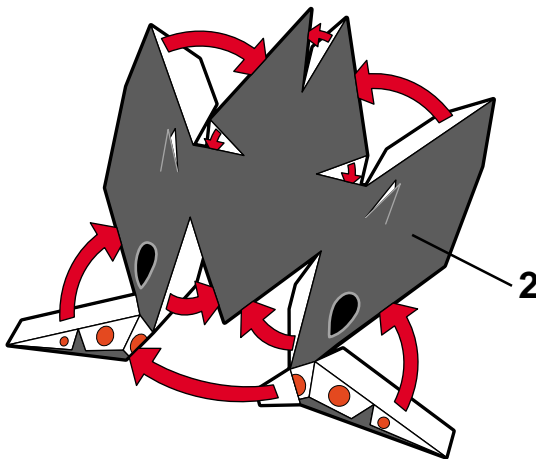

Reference photo

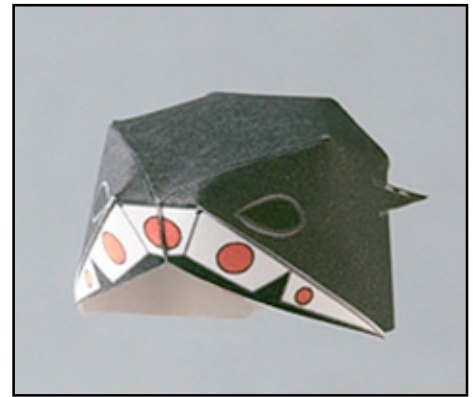

3. Assembly of Neck

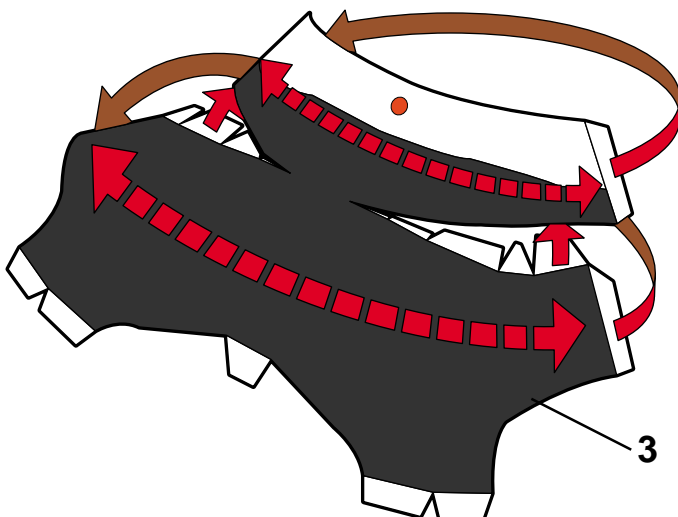

Reference photo

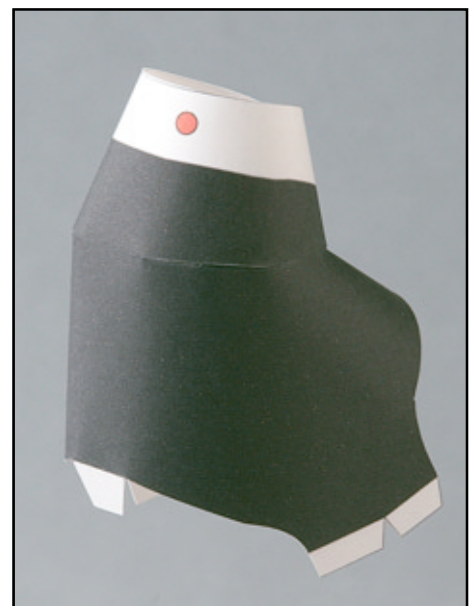

3 Assembly

Please refer to the "Basic working method and markings" symbol chart on Page 2 to assemble each part.

Indication of Working Methods



Fold or Curve



Glue

Instructions for Juan Fernandez Fur Seal

4. Assembly of Belly Fold each relevant part according to the assembly symbols.

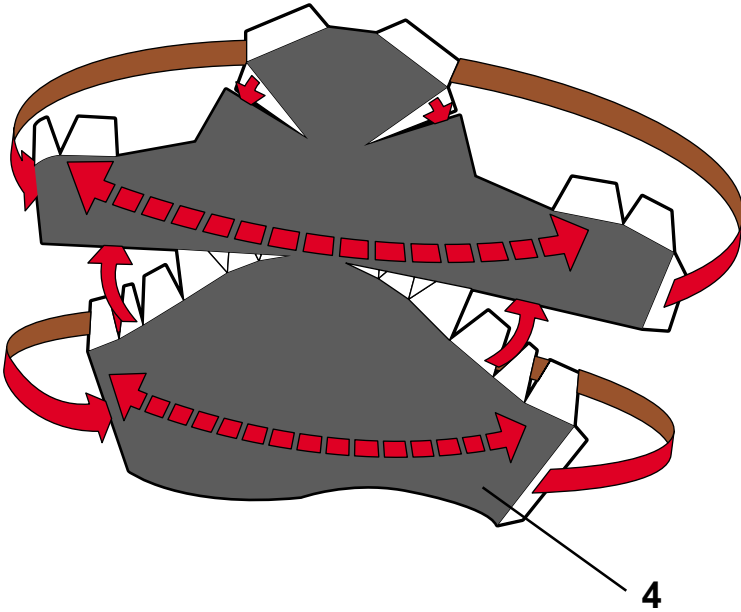

Reference photo

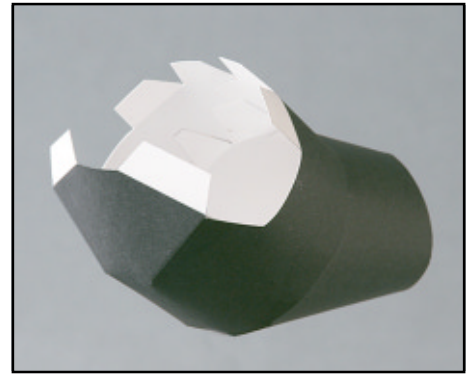

5. Assembly of Tail

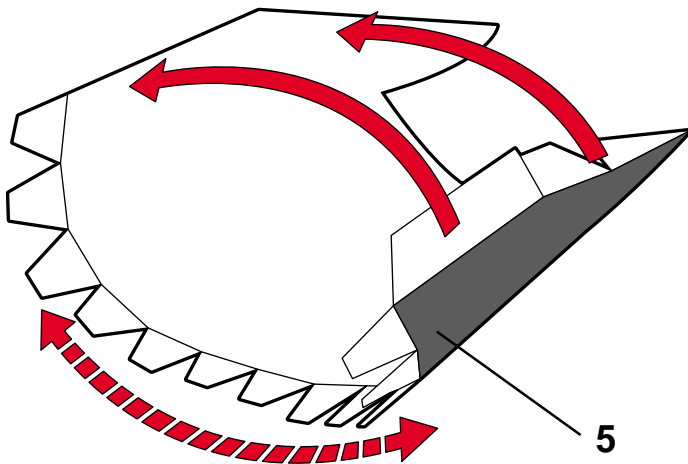

Reference photo

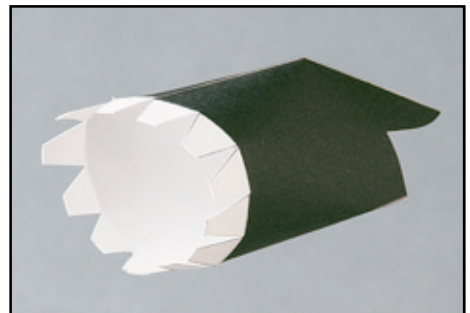

3 Assembly

Please refer to the "Basic working method and markings" symbol chart on Page 2 to assemble each part.

Indication of Working Methods



Fold or Curve



Glue

Instructions for Juan Fernandez Fur Seal

6. Assembly of Forelegs1

Fold each relevant part according to the assembly symbols.

*Assemble each part in pairs.

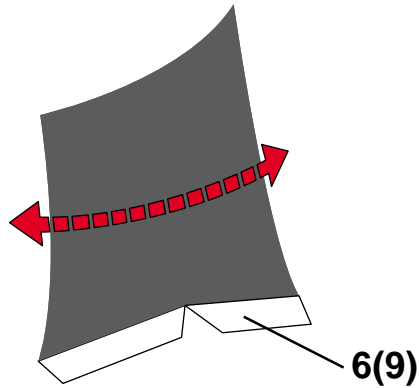

Reference photo

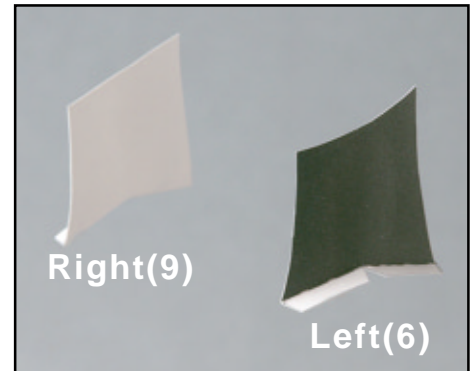

7. Assembly of Forelegs2

*Assemble each part in pairs.

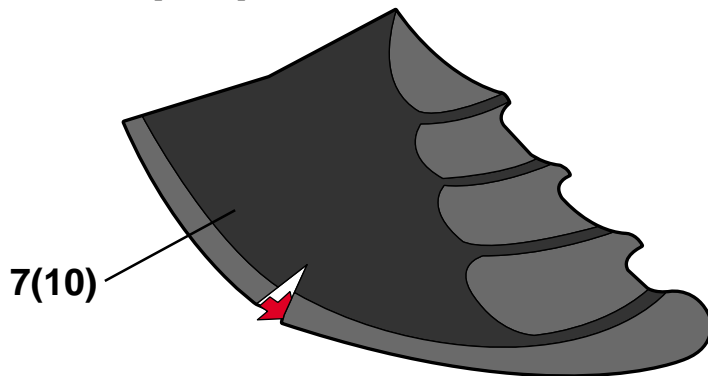

Reference photo

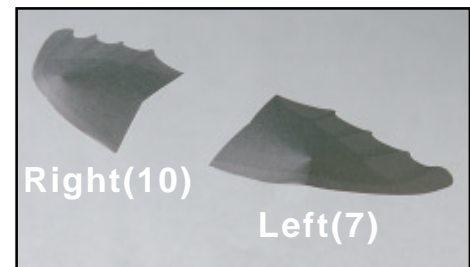

8. Assembly of Hind legs

*Assemble each part in pairs.

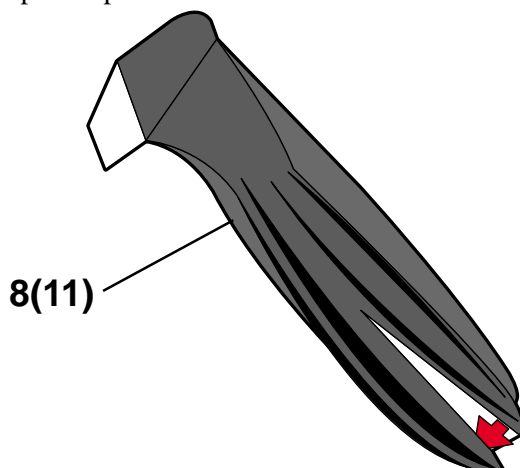

Reference photo

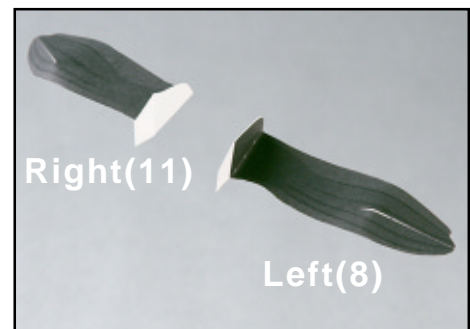

3 Assembly

Please refer to the "Basic working method and markings" symbol chart on Page 2 to assemble each part.

Indication of Working Methods

 Fold or Curve  Glue

Instructions for Juan Fernandez Fur Seal

Please use the ● dots on each component as reference when gluing surfaces.

9. Finish Assemble according to steps ① through ⑧.

Procedure

- ① Glue the tail to the trunk.
- ② Glue the front side of the neck to the trunk.
- ③ Glue the back side of the trunk to the neck.
- ④ Glue the front flippers 1 to the front flippers 2.
- ⑤ Glue the parts completed in steps ③ and ④.
- ⑥ Glue the hind limbs to the part completed in step ⑤.
- ⑦ Glue the snout to the head.
- ⑧ Glue the parts completed in step ⑦ and ⑥.

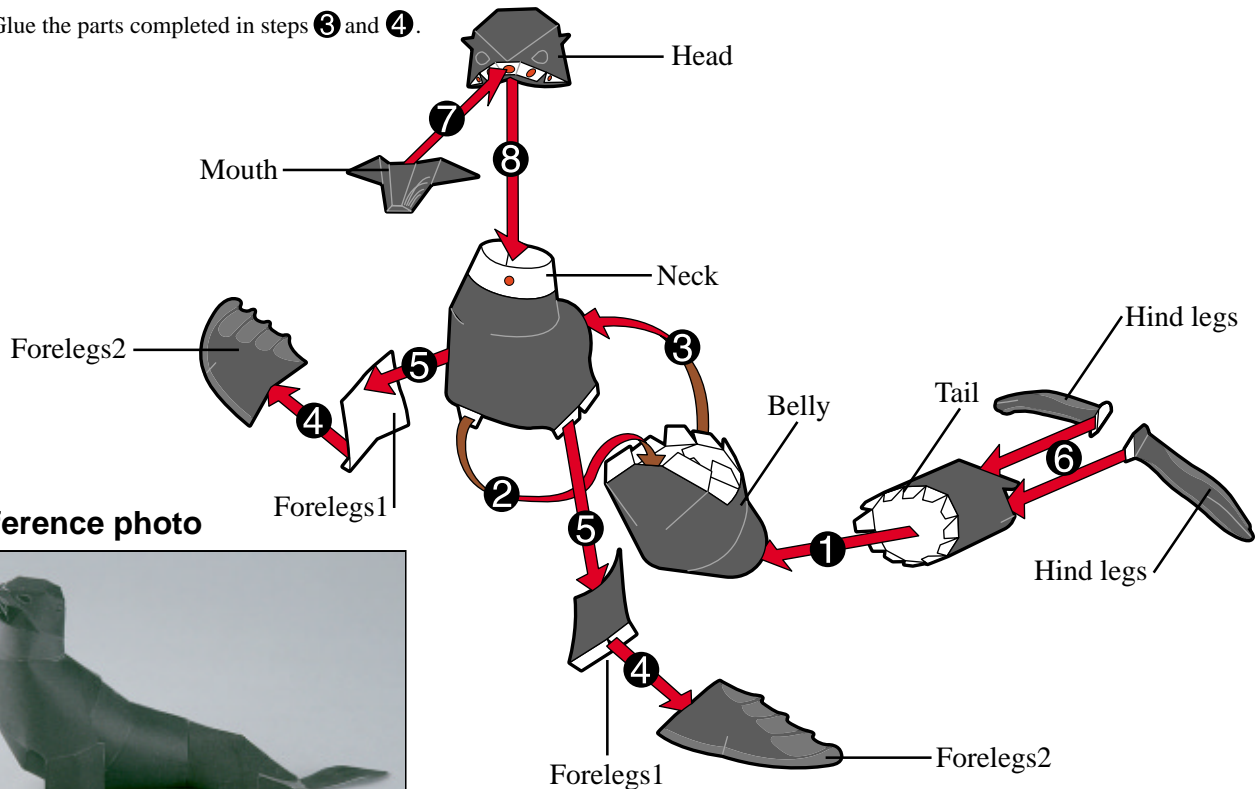

Reference photo



Assembly of the Pedestal

*Display the completed paper sculpture of the Fernandez fur seal on the pedestal. Assemble 12 and glue the sculpture on the pedestal where indicated.

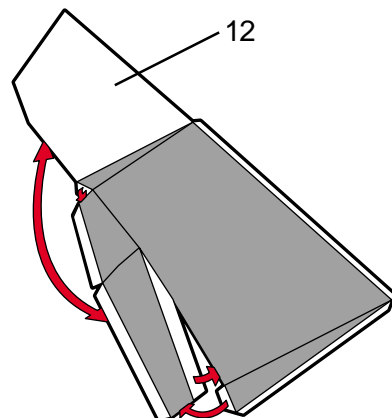
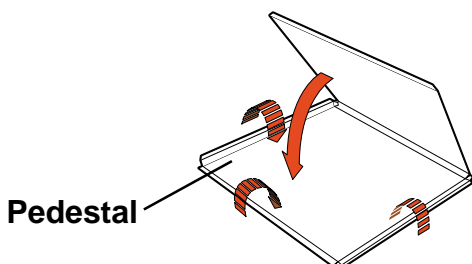

4 Completion

Here are pictures of the completed models.
Please refer to them when assembling and painting.



Colored Juan Fernandez Fur Seal

Photo of realistically colored paper sculpture.



Uncolored Juan Fernandez Fur Seal

Uncolored sculpture with textured paper.



Juan Fernandez Fur Seal, Rare Animal

The Fernandez Fur Seal is relatively slim compared to other stocky fur seal species. The name of this seal with dark brown fur originated from its habitat, the Juan Fernandez Islands. Flocks of Fernandez fur seals are found in caves and cliffs facing the ocean and rocky shorelines. It is believed that they migrate in the ocean current within a small range from winter to spring. They mainly feed on fish, squid, and sometimes lobsters. Mating occurs in November, and females give birth to pups from the end of November to the beginning of December. The home to the Fernandez fur seal, Juan Fernandez Islands are an archipelago located approximately 700 km off the Chilean coast in South America. Millions of Fernandez fur seals were found in the 17th century until large scale exploitation for fur began. In a span of about 130 years, about 4 million seals were captured, and the species were thought to be extinct at the end of the 19th century. The population is now recovered to about 4000, thanks to conservation programs.